

Technical data sheet

Product features



Potato peeler 100-150 kg/h 5 kg

Model

SAP Code

00007309



- Material: Stainless steel
- Control type: Mechanical
- Device capacity [l]: 5.00
- Maximal production per hour [kg/h]: 150
- Safety element: magnetic lid safety switch
- Start /stop: Yes
- Timer: Yes
- Transfer type: Strappy
- Water supply connection: 3/4"
- Drain valve diameter: 50 mm
- Abrasive: Snadno odnímatelné brusné plochy a disk pro jednodušší čištění a výměnu
- Additional information: transparent plexiglass lid for checking all stages of processing

SAP Code	00007309	Power electric [kW]	0.270
Net Width [mm]	402	Loading	400 V / 3N - 50 Hz
Net Depth [mm]	609	Device capacity [l]	5.00
Net Height [mm]	561	Maximal production per hour [kg/h]	150
Net Weight [kg]	30.00		

Technical data sheet

Technical drawing



Potato peeler 100-150 kg/h 5 kg

Model

SAP Code

00007309

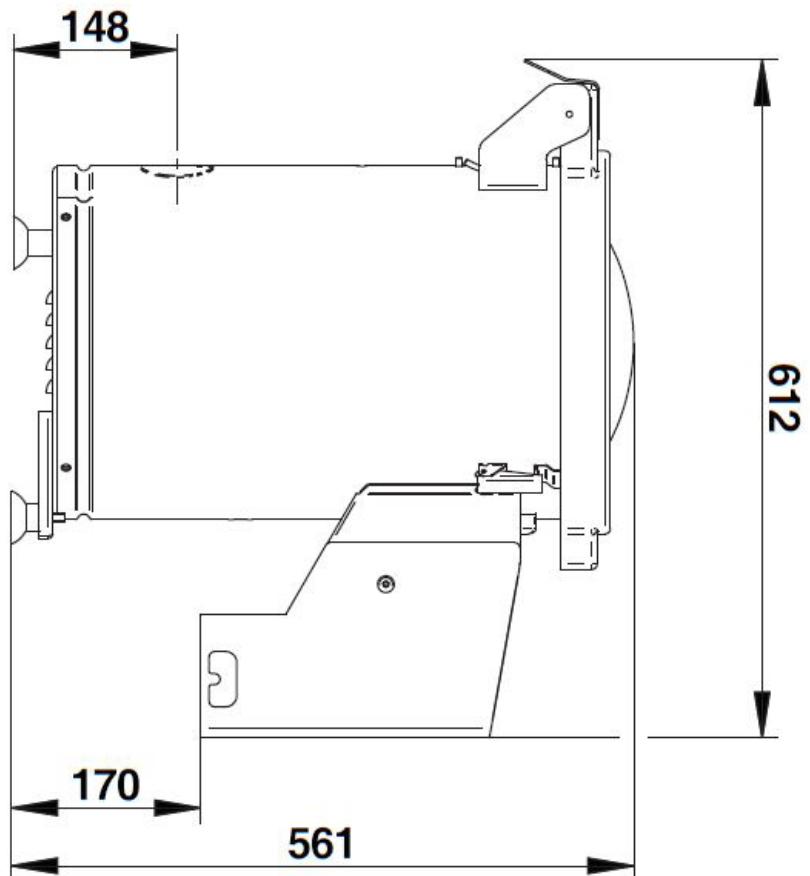
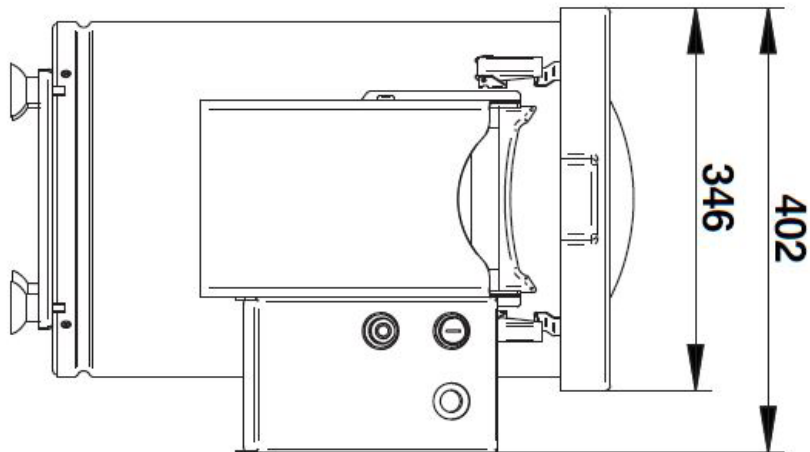

Technical data sheet

Product benefits



Potato peeler 100-150 kg/h 5 kg

Model

SAP Code

00007309

1

All-stainless steel construction

harmless to health for contact with food
robustness

- perfect sanitation
- long service life

2

Lid safety switch

safe operations

- protection of workers from injury caused by incorrect use

3

Transparent lid

visual inspection of all stages of processing

- product savings due to the possibility of checking the state of processing

Technical data sheet

Technical parameters



Potato peeler 100-150 kg/h 5 kg

Model

SAP Code

00007309

1. SAP Code:

00007309

2. Net Width [mm]:

402

3. Net Depth [mm]:

609

4. Net Height [mm]:

561

5. Net Weight [kg]:

30.00

6. Gross Width [mm]:

520

7. Gross depth [mm]:

520

8. Gross Height [mm]:

670

9. Gross Weight [kg]:

32.00

10. Device type:

Electric unit

11. Material:

Stainless steel

12. Power electric [kW]:

0.270

13. Loading:

400 V / 3N - 50 Hz

14. Device capacity [l]:

5.00

15. Control type:

Mechanical

16. Safety element:

magnetic lid safety switch

17. Start /stop:

Yes

18. Timer:

Yes

19. Transfer type:

Strappy

20. Maximal production per hour [kg/h]:

150

21. Additional information:

transparent plexiglass lid for checking all stages of processing

22. Water supply connection:

3/4"

23. Drain valve diameter:

50 mm

24. Abrasive:

Snadno odnímatelné brusné plochy a disk pro jednodušší čištění a výměnu